

ISO View: 5W-G150-8

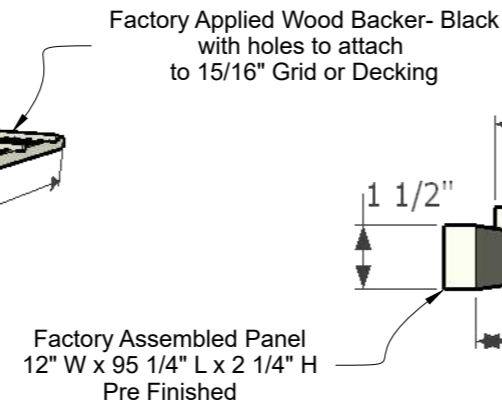

End View

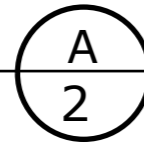
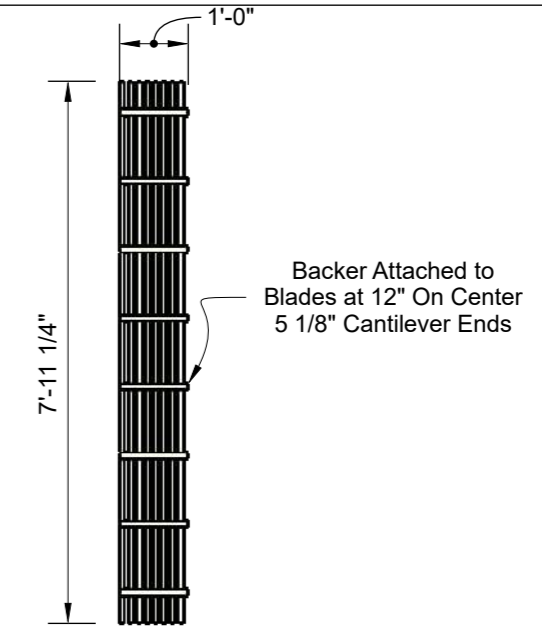
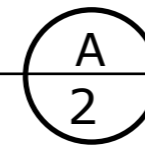

Top View

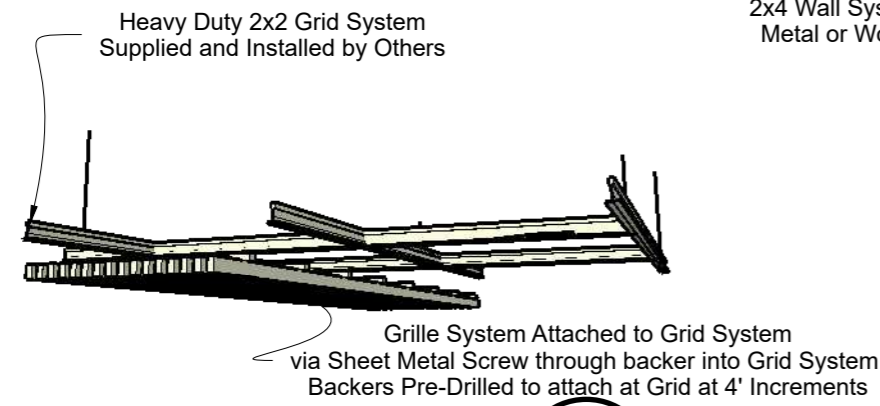
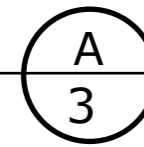

ISO View: 2x2 Grid

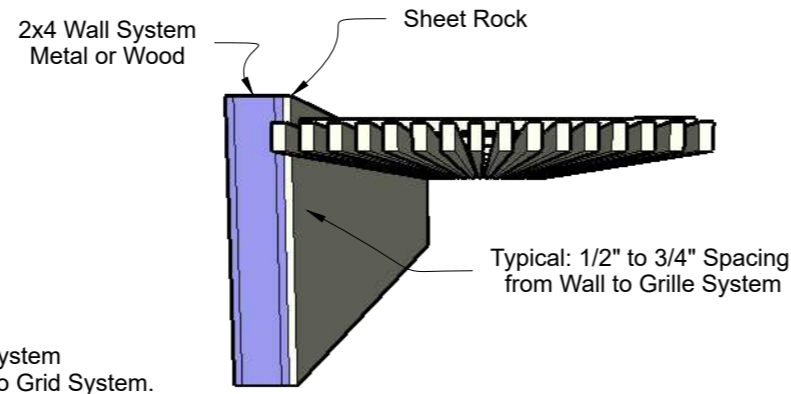
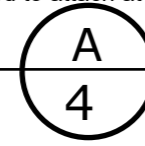

Perimeter View

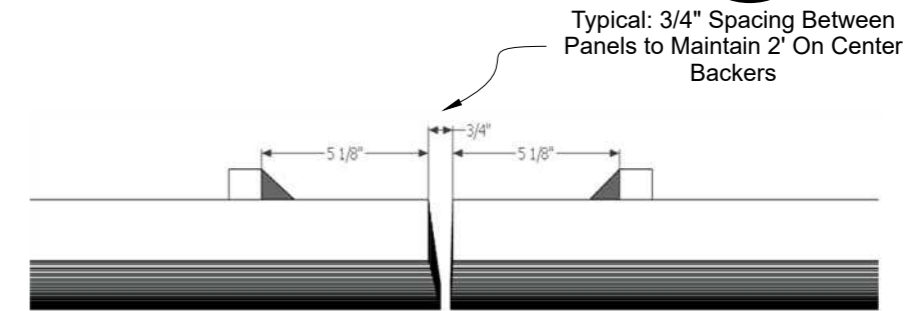
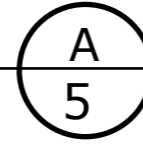

Panel Abutment

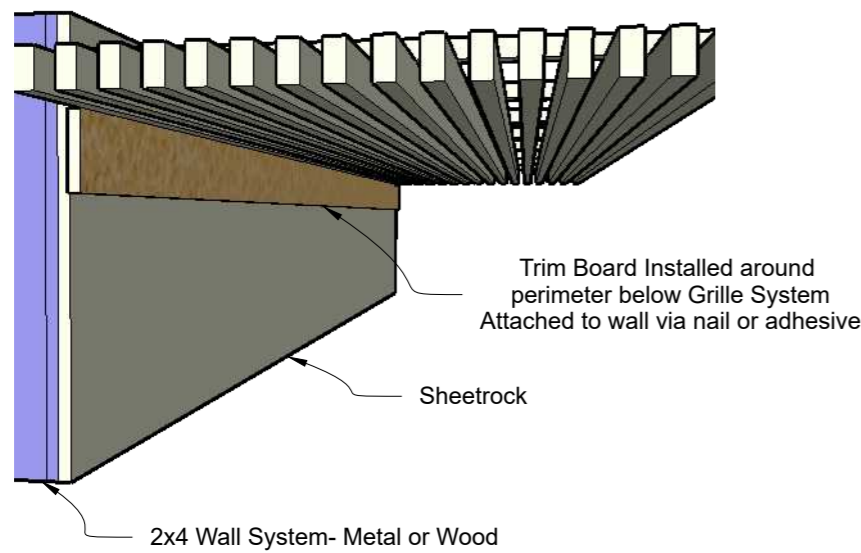
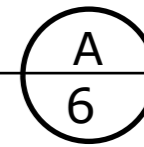

Perimeter: Trim Below

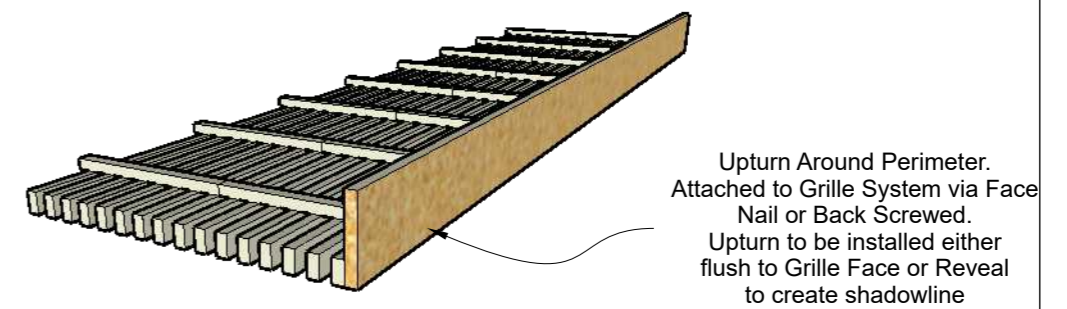
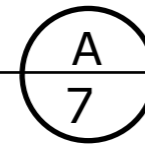

Perimeter: Upturn

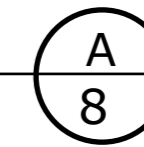

5th Wall Designs, LLC
 3011 82nd Lane NE
 Minneapolis, MN 55449
 Client Name
 12345 Main Street
 New York, NY 00000
 Tel: 000.000.0000
 Phone: 763-780-4935
 fifth wall designs

PROJECT
 PROJECT NO.
 1
 ISSUE
 DRAWN BY
 GM

System Details